

# Door Closers

## Floor Spring

### MAB Floor Spring 7600 - up to 120kg door

- Fix size EN3 for doors less than 950mm width. EN4 for doors less than 1100mm.
- Max door weight 120kg.
- Universal for right, left and double action doors.
- For internal and external doors.
- Cement box only 40mm height, to suit thin slabs.
- Cast iron body to ensure strong durability.
- Adjustment in all direction within cement box.
- Pivot point 51-59mm without re-locating the cement box.
- Hydraulic control over 130° in both swings.
- Closing speed and latching speed controlled by two independent thermodynamic valves to ensure consistent performance.
- Overpressure valve relief.
- Interchangeable spindles: +0 to +15mm.
- Cover plate in polished s/steel, satin s/steel.
- EN1154 certified.
- CE mark.

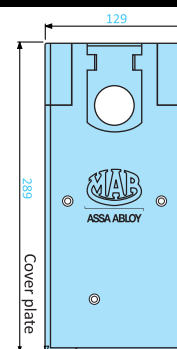

MAB Floor Spring (Body Only)		
Version	Model Description	Item Code
MAB 7600	MAB 7600 Series Floor Spring (90° Hold Open) EN3	MAB 7635
MAB 7600	MAB 7600 Series Floor Spring (90° Hold Open) EN4	MAB 7645
For wooden doors, please order Cover plates, spindles, bottom arms & top pivot separately.		
For frameless glass doors, please order cover plates, spindles & glass fittings separately.		

Cover plates		
AC619	Cover Plates for MAB 7600 Series (AC619) INOX	MA06190

### Item code reference according to size and hold open

ART. **76** **XX**

EN Size

**3** = 22 Nm

max. 950 x 2300

**4** = 28 Nm

max. 1100 x 2400

Hold open

**5** = 90°

**0** = 105°

**2** = X

### Adjustment within cement box:

- Angular 4°
- Front 7mm
- Vertical 2mm

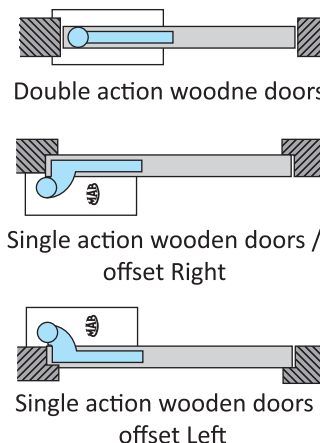
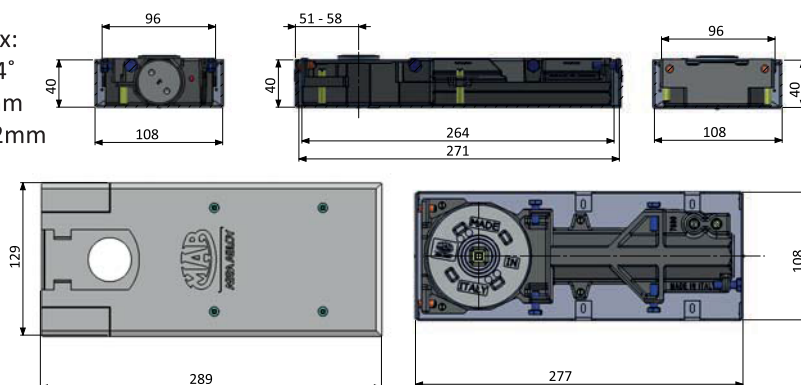

### MAB Floor Spring 7700 - up to 170kg

- Adjustable power EN2-4 by means of stepless governor which coupled with high efficiency allows a real personalization of opening/closing forces.
- Universal for right, left or double action doors.
- Suitable for timber, metal and glass doors.
- Recommended for all types of doors, external and internal.
- Large range of adjustment within cement box to solve possible alignment problems on site without taking down the door.
- Opening up to 180° in both swings with hydraulic control from approx 150°, hold open at 90° as standard (also available hold open 105° or any angle between 150° and 180°. The non hold open version has a back stop at 150°.
- Closing speed controlled by two easily adjustable independent thermostatic valves: soft closing or powerful latching action to ensure proper closing also in case of hard-to-latch locks.
- Over pressure valve to safeguard the mechanical components in case of abuse.
- Mechanical back check to prevent uncontrolled openings.
- Interchangeable spindle  
+0 to +15mm floor lever clearance.
- For Rectangular German Spindles
- Architectural finishes coverplates in Satin s/steel (INOX) and Polished brass as standard. Also available in Polished s/steel finish.
- With quality certification according to the EN1154 and a certification up to 1,000,000 cycles. CE mark.



MAB Floor Spring (Body Only)		
Version	Model Description	Item Code
MAB 7700	MAB 7700 Series Floor Spring (90° Hold Open)	MAB 7705
<i>For wooden doors, please order Cover plates, spindles, bottom arms &amp; top pivot separately.</i>		
<i>For frameless glass doors, please order cover plates, spindles &amp; glass fittings separately.</i>		

Cover plates	Item Code
MAB 7700 Cover Plates for 7700 series (INOX)	MA0534I0
MAB 7700 Cover Plates for 7700 series (Brass)	MA0534P0

### Item code reference according to size and hold open

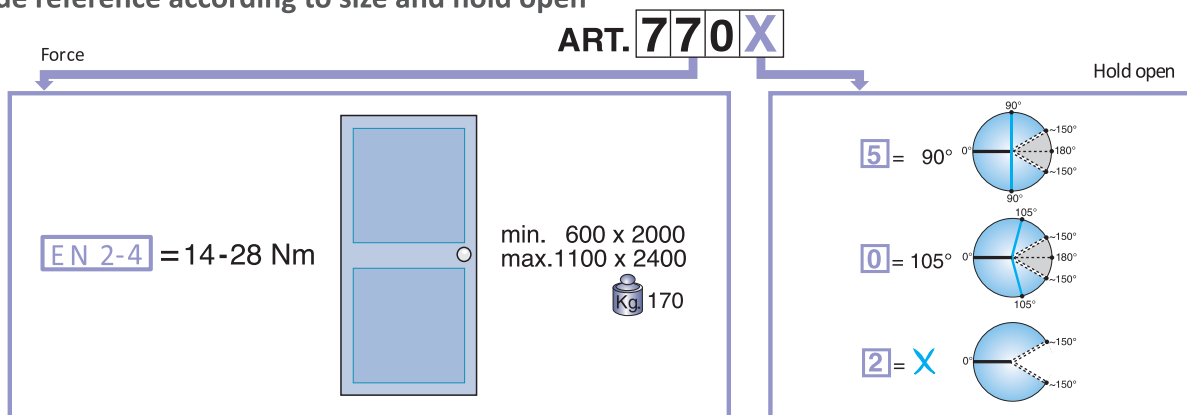

Adjustment within cement box:

- angular 4°
- front 10mm
- vertical 9mm

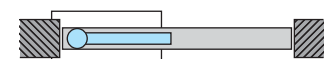
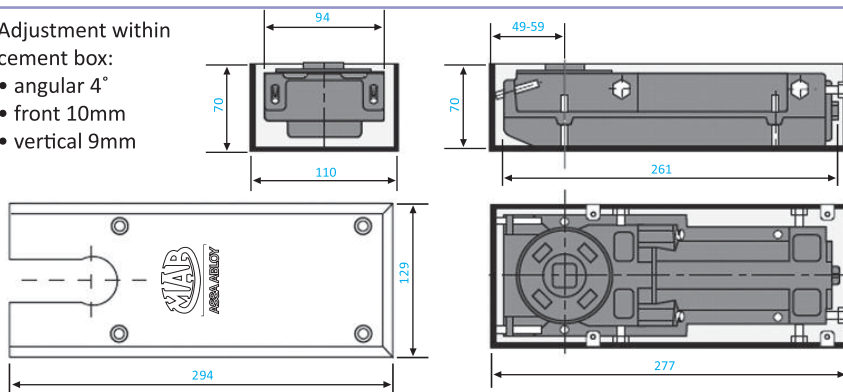

Double action doors

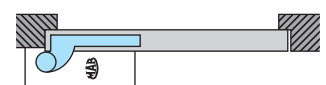

Single action doors / offset Right

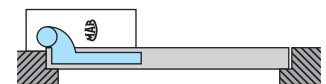

Single action doors / offset Left

### MAB Floor Spring Accessories

**German standard rectangular spindles for MAB Floor Springs:** choose suitable spindle according to your door requirements to be used with MAB floor springs. Compatible with all MAB floor springs.

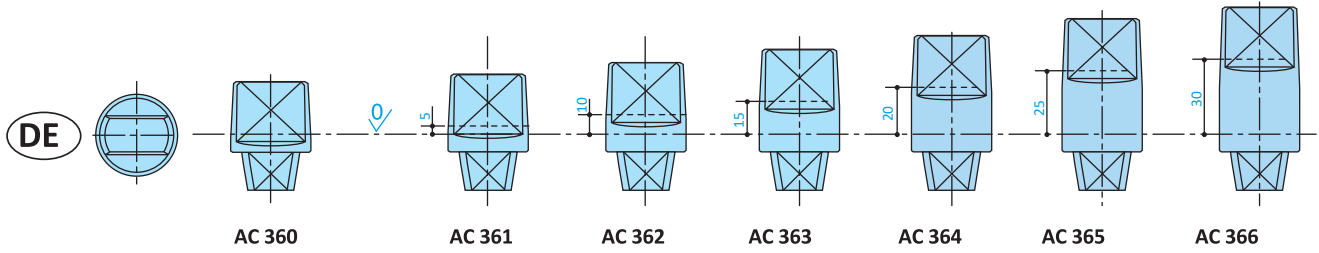

### Arms for double action wooden doors for MAB Floor Springs

**AC 393**

Reversible bottom arm in steel for double action doors. Rectangular German spindle.

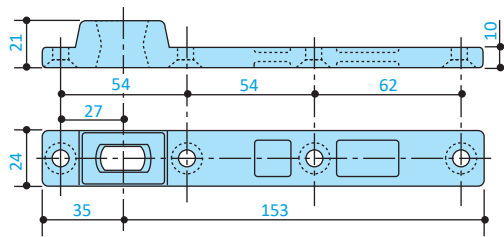

**Kg.** max. 300

**AC 8**

Double acting top pivot.

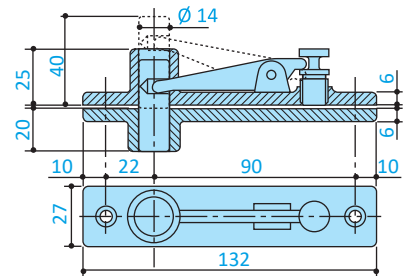

**Kg.** max. 300

### Arms for single action wooden doors MAB Floor Springs (Offset right and left reversible)

**AC 392**

Right and left Reversible bottom arm in steel for single acting doors, 36 mm offset. Rectangular German socket.

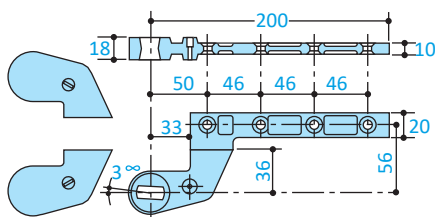

**Kg.** max. 300

**AC 384**

Top pivot in steel for left or right offset doors 36 mm offset.

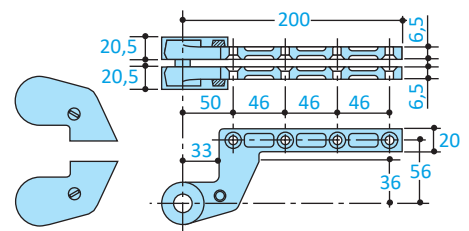

**Kg.** max. 300

### Door handing reference

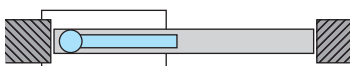

Double action wooden doors

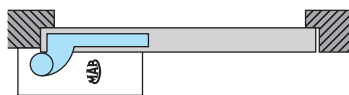

Single action doors / offset Right

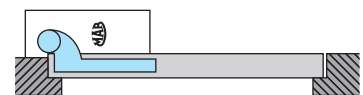

Single action doors / offset Left

### EXIDOR 900 series floor spring - up to 600kg doors



HEAVY DUTY FLOOR SPRINGS WITH BACKCHECK

BS EN 1154



Generally considered the best in the market, the Exidor 900 series double cam mechanism floor spring range fits discreetly into the floor, giving improved resistance to interference and vandalism, and they are particularly suited to shops, offices, hospitals etc.

Available in both single and double action with back check, the features adjustable power EN 1-6 and can be used for doors up to 600kg. Available as a complete unit, or as a mechanism only where replacements are required. The 900 series is equipped with a unique centre controlled closing mechanism which ensures smooth and quiet closing to the central closed position from either direction.

Option includes 90°, 105° and 120° hold open, delayed action and heavy duty backcheck for use on heavier doors. Other accessories consist of extra height spindles, 200° cam and gel infill for improved water resistance. The cover plate is Satin s/steel as standard (also available Polished s/steel and Polished Brass).



#### Features:

- Closing Force: EN 1-6
- Door Size (Max): 1400mm width
- Door Weight: Max 600kg
- Mechanism: Rack & Pinion
- Angle of opening: 180°
- Power adjustment: by Spring
- Adjustable sweep speed
- Latching speed
- Backcheck
- Hold open at 90°
- CE Mark

Exidor 900 series floor spring			
Item	Description	Item Code	Finish
Exidor993	Heavy Duty Floor Springs (Box Only) C/W Spindle	Exidor-20030075	None
<i>Please order cover plates, bottom arm &amp; top pivot separately.</i>			

Exidor Floor Spring - Accessories			
Item	Description	Item Code	Finish
ExidorFSA	Wooden Door Bracket - Double Action Fitting Set for Exidor993 (including bottom arm & top pivot)	Exidor-20030047	SSS
ExidorFSA	Floor Spring Carpet Tray 10mm	Exidor-20030352	None
ExidorFSA	Anti Bacterial Gel	Exidor-20030033	None

Dimensions (measurements in millimetres):

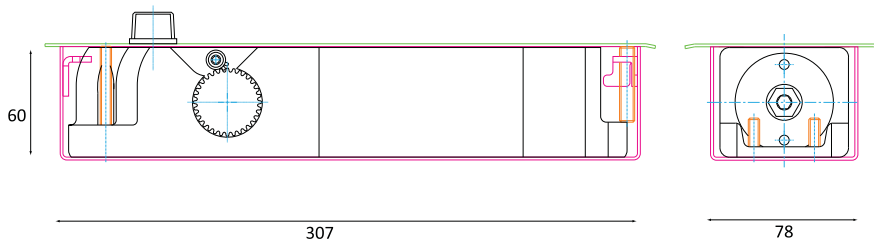

Cover plates

