

BRASS HANDLES

MANDELLI 1953

MADE IN ITALY

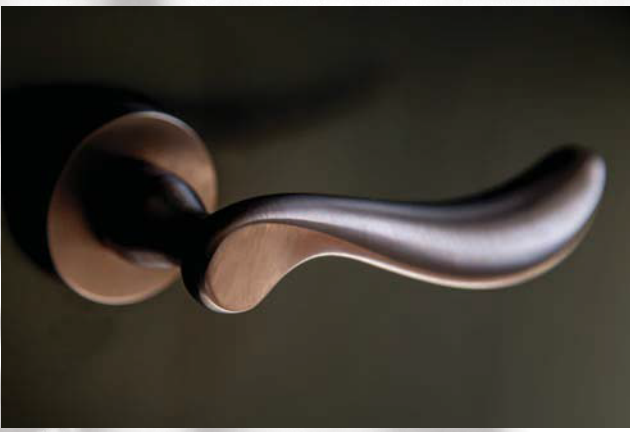

FORTRESS LAND

FLUXCOTING INFORMATION OF MANDELLI BRASS HANDLES

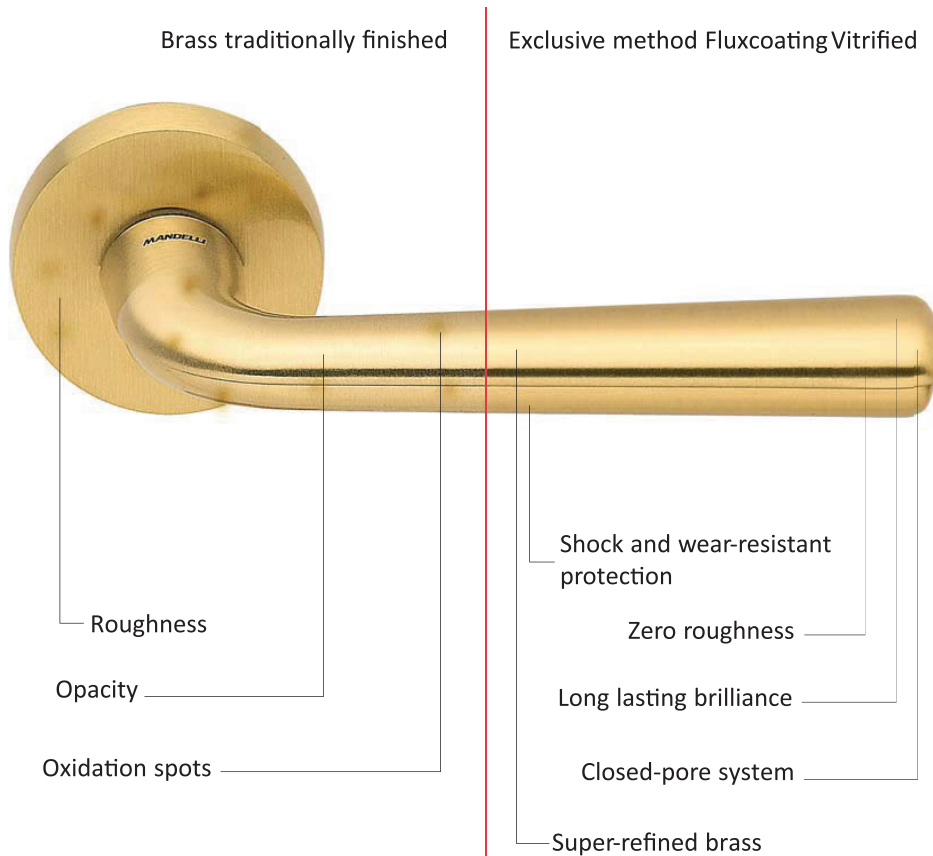

Fluxcoating Vitrified, is a unique protective treatment developed by Mandelli Engineering to enhance the brass appearance and preserve it for a long time.

Through various product pre-treatments and this coating with special resins, a very high resistance to weather conditions, shocks and abrasion is obtained, whilst the natural shiny look of the polished brass remains unchanged.

Traditional coatings may involve dripping or dull-spotted brass surfaces, where fluxcoating Vitrified treatment means long-lasting and unchanged brass brilliance in every piece.



FLUXCOATING - VITRIFIED TEST

Test name	Description	Results
Covering thickness	Thickness of the protective layer applied.	Over 120 micron.
Hardness test		Over 3 H.
Corrosion test in salty fog	ASTM B117/73 in NaCl solution. Samples are kept for 420 hours in a chamber with a 5% solution of NaCl, under following conditions: 99% humidity; 1 ATM constant pressure; 96°F temperature.	Over 420 hours without alterations.
Lattice test in salty fog	Salty fog test ASTM B117/73 with lattice according to standards DIN 53151.	After 300 hours minimal alterations on lattice points.
Adhesion test	Check of 1 square centimeter (1x1 mm) with ribbon pull.	No varnish detachment.
Light exposure test	Lamp power 1,500 W. Attenuating filter 315 mm. Internal temperature of the chamber 113/140°F.	After 148 hours no notable colour variation in comparison with the masked zone.
Heat resistance test	Temperature 158°F. Duration 24 hours.	No alteration of the surface.
Thermal shock resistance test	Lower temperature limit: -13°F. Upper temperature limit: 131°F. Number of cycles: 100.	No breakage/alteration of the surface.
Humidity resistance test	Temperature 104°F. Humidity 95%. Duration 168 hours.	No hints of corrosion.
Test of resistance to cement corrosion	Immersion in liquid cement for 14 days.	Very light corrosion spots near the holes.
Test of resistance to caustic soda corrosion	Caustic soda solution: 5%. Duration of the immersion: 24 hours.	No notable alteration of the surface.
Test of resistance to the corrosion of raw plastic cement	Temperature: 104°F. Humidity 95%. Duration: 14 days.	No notable variation of the surface.
Chemical resistance	Cleaning with household detergent products. Once per day for 7 days.	Slight alteration of the colour.
Resistance to vibration of the packed load	Frequene 8-55 Hz. Vibration acceleration: 1.25 G. Cycle period: 120 sec.	No significant damage on the sample and the packing.
Wear and tear resistance test	Applied pressure: 5 N (20 Kgf). Number of strokes: 1,000. Duration: 14 days.	No decolourizing or damage to vanish.
Mechanical components wear and tear test	Opening simulation with 8 Kg pressure (DM 236 of 1989).	Over 1.000.000 cycles.

Door Handles

Brass Lever Handle

Fortress Land Door Hardware

AVAILABLE FINISHES FOR MANDELLI BRASS HANDLES



The elegance of gold or the modern brightness of Chrome, the antique affect or the refined satin. *MANDELLI* offers a range of finishes suitable for everyone's taste and home style.



03 polished brass



04 satin brass



26 polished chrome



26D satin chrome



MSN mat satin nickel



MB mat black



IB imperial bronze



MBR mat bronze



PVD gold



PVD inox



POW/AW white

The IB finish is obtained by natural elements in which the finishes might not be uniform.

Door Handles

Brass Lever Handle

Fortress Land Door Hardware

DECORATIVE LEATHER COLLECTION FOR MANDELLI HANDLES



Decorative leather covers available for specific model.



Available Colours



Model that can be covered by Leather

360 TUC



1340 Hartu



1511 Aurora



1160 Telis



1200 Melody



460 Totem

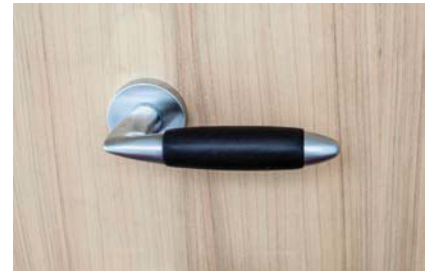

1671 Bilbao



Door Pull 1675



Door Handles

Brass Lever Handle

Fortress Land Door Hardware

SPECIAL 91

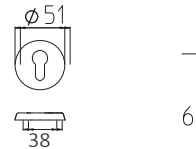
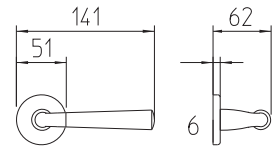

Model	Description	Finish	Code
Special 91	S91 Door handle on rose	Polish Brass, Satin Brass 03/04	8012790159150
Special 91	S91 Door handle on rose	Polish Chrome, Satin Chrome 26/26D	8012790159136
Special 91	S91 Door handle on rose	MBR mat bronze	8012790159112

Lever Handle on both sides including euro cylinder covers, a spindle & bolt through fixing kit.

NORMA

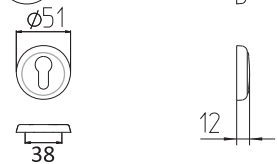
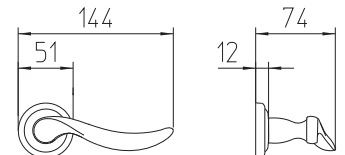

Model	Description	Finish	Code
Norma	1211 Door handle on rose	04 Satin Brass	8012790294424
Norma	1211 Door handle on rose	MBR mat bronze	8012790217706

Lever Handle on both sides including euro cylinder covers, a spindle & bolt through fixing kit.

Aurora

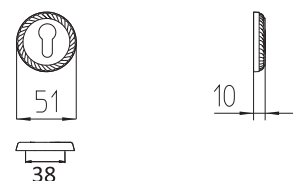
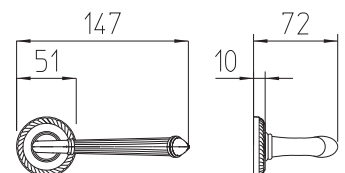

+ PVD Finish* available with minimum order quantity

Model	Description	Finish	Code
Aurora	1511 door-handle on rose	03/04 polish brass/satin brass	8012790275317

Lever Handle on both sides including euro cylinder covers, a spindle & bolt through fixing kit.

Door Handles

Brass Lever Handle

Fortress Land Door Hardware

Alissa



03/04 Polished brass/Satin brass

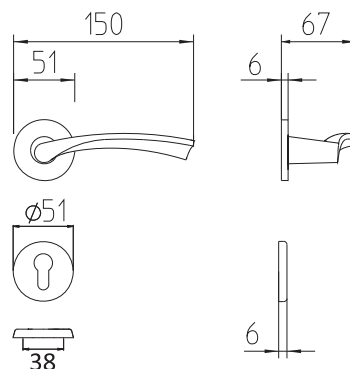

Model	Description	Finish	Code
Alissa	1471 Door handle on rose	MBR Mat Bronze	8012790287990
Lever Handle on both sides including euro cylinder covers, a spindle & bolt through fixing kit.			

LORD



04/03 satin brass / polish brass



MBR Mat Bronze

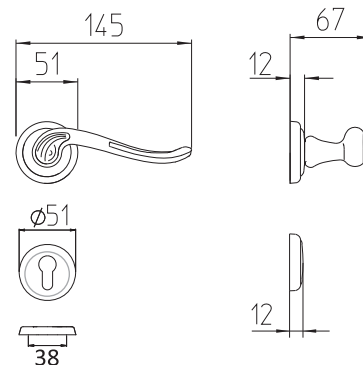

MBR Mat Bronze

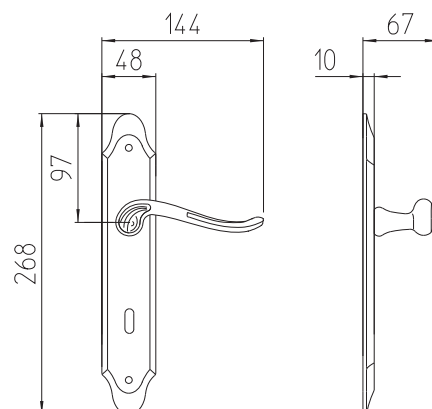

Model	Description	Finish	Code
LORD	1020 Door handle on Plate	MBR mat bronze	8012790200562
LORD	1020 Door handle on Plate	03/04 polish brass/satin brass	8012790200531

Door Handles

Brass Lever Handle

ZEIT

design by Marco Piva



1721
door-handle on rose
design



03 polished brass



04 satin brass



26 polished chrome



26D satin chrome

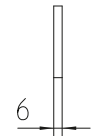
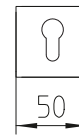
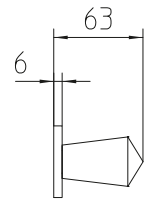
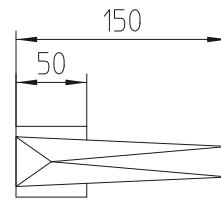

DEMI



3181
door-handle on rose
design



26/26D
polished chrome/satin chrome



26/AW
polished chrome/white

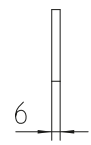
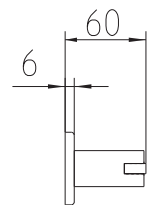
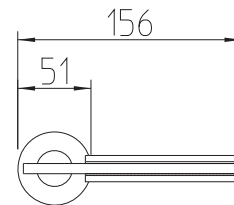

PIRAMID



1251
door-handle on rose
design



26D satin chrome



MSN mat satin nickel

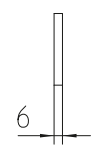
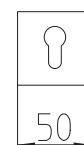
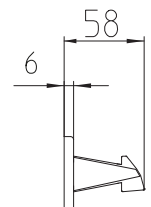
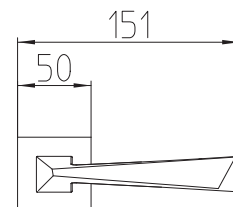

Door Handles

Brass Lever Handle

Carre

Design by Piet Billekens



1621
door-handle on rose
design



03 polished brass



04 satin brass



26 polished chrome



26D satin chrome

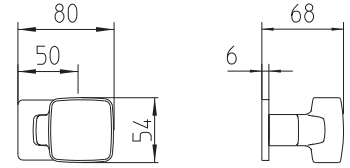

+ PVD Finish* available

Fenix

Design by Piet Billekens



1601
door-handle on rose
design



03 polished brass



04 satin brass



26 polished chrome



26D satin chrome

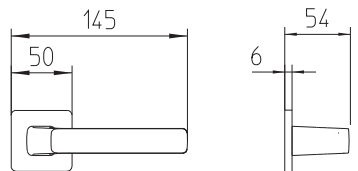

+ PVD Finish* available

LED



1091
door-handle on rose
design



03 polished brass



26 polished chrome



26D satin chrome



MBR mat bronze

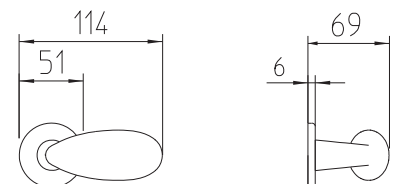

+ PVD Finish* available

* Please check Minimum Order Quantity for PVD finish

Door Handles

Brass Lever Handle

BILBAO
design by Piet Billekens



1671
door-handle on rose
design / contemporary



03 polished brass



04 satin brass



26 polished chrome



26D satin chrome

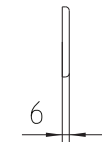
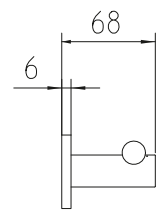
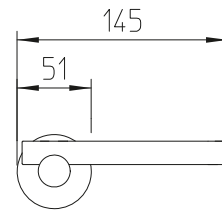

ARA



3191
door-handle on rose
contemporary



26D/26 Satin Chrome/Polish



MBR Mat Bronze



MSN Mat Satin Nickel

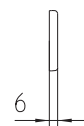
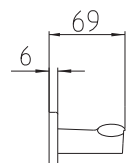
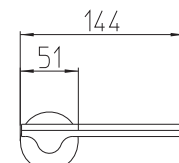

ISI



1081
door-handle on rose
contemporary



26D Satin Chrome



03 Satin Brass



MSN Mat Satin Nickel

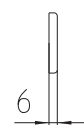
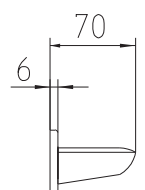
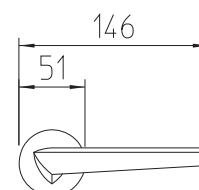

Door Handles

Brass Lever Handle

Fortress Land Door Hardware

ZANTE



1301
door-handle on rose
contemporary



04 satin brass



26D satin chrome



IB imperial bronze

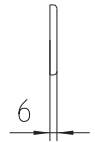
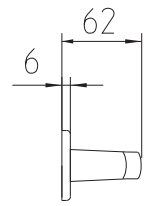
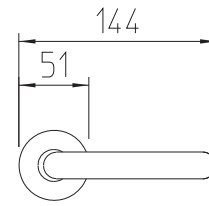

LARIO



1681
door-handle on rose
contemporary



26D satin chrome

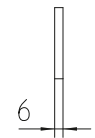
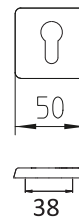
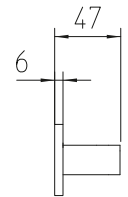
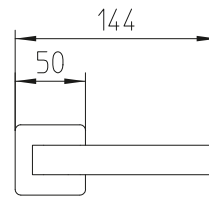

FUSILLA

design by Alessandro Dubini



1731
door-handle on rose
contemporary



03 polished brass



04 satin brass



26 polished chrome



26D satin chrome

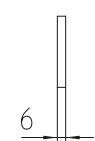
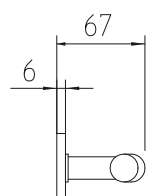
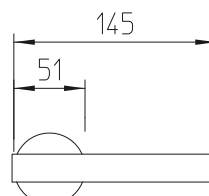

Door Handles

Brass Lever Handle

Fortress Land Door Hardware



NAXOS



Polish Brass / MARQUINA Marble



Polish Brass / Calacatta Vagli Marble

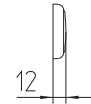
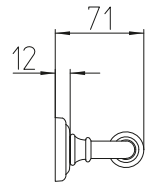
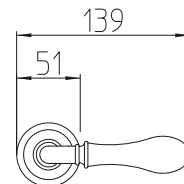

8011
door-handle on rose
classic

PAROS



Polish Brass / MARQUINA Marble



Polish Brass / Calacatta Vagli Marble

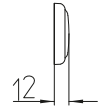
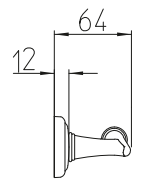
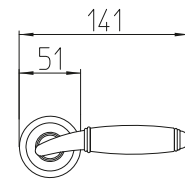

8001
door-handle on rose
classic

Installation instruction for lever handle on Rose for Mandelli Lever Handles

Door-handle on rose with TG tight-through system $\varnothing 38\text{mm}$ (bolt through fixing kit)

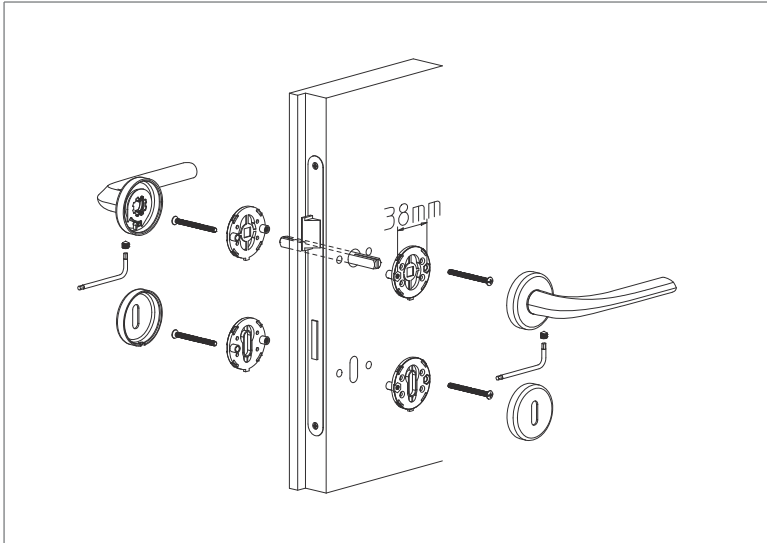

Door-handle on sub-squared rose with TG tight-through system $\varnothing 38\text{mm}$ (bolt through fixing kit)

