

Motorised Roller Blinds



Motorised Roller Blinds

Motorised roller blinds can be installed both indoor and in between window panels. Roller blinds come in three ranges: typical, wire and guide rail-types. Depending on the installation methods, roller blinds can be installed on inclined windows as well. Interior roller blinds are relatively easy to install, and are durable. The daylight penetration of roller blinds can vary as the solar transmission rate and solar reflection rate is highly dependant on the colors and openness factors of the fabrics. Roller blinds with fabrics that have a lower penetration rate of 1-3% are usually recommended to be installed at the southern and western sides where the volume of sunlight is relatively higher. Similarly, roller blinds with fabrics that have a higher penetration rate of over 3% is recommended to be installed at eastern side where the volume of sunlight is relatively lower.

Benefits Of Motorised Roller Blinds

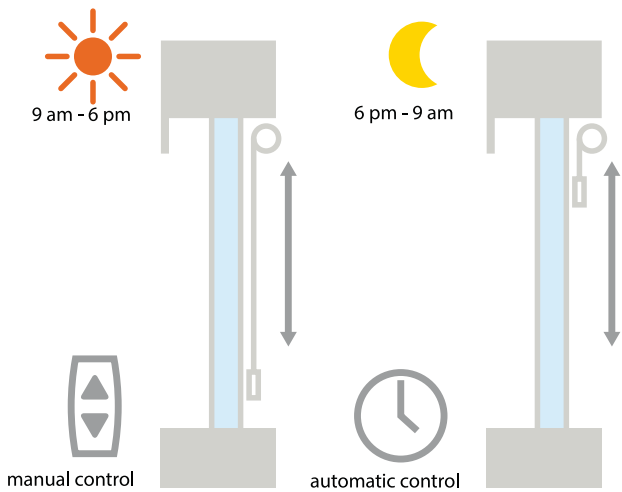

Benefits

Motorised roller blinds when integrated with a facade building control system easily. Control the inflow of solar radiation by automatically lowering or raising the blind's fabric to the desired position. Since the roller blinds are easily adjustable, the blinds can be partly or totally lowered or raised depending on the need to let in the sunshine. And when this function is integrated with other third party system (HVAC, lightings), more energy savings can be realised.

Zone Control

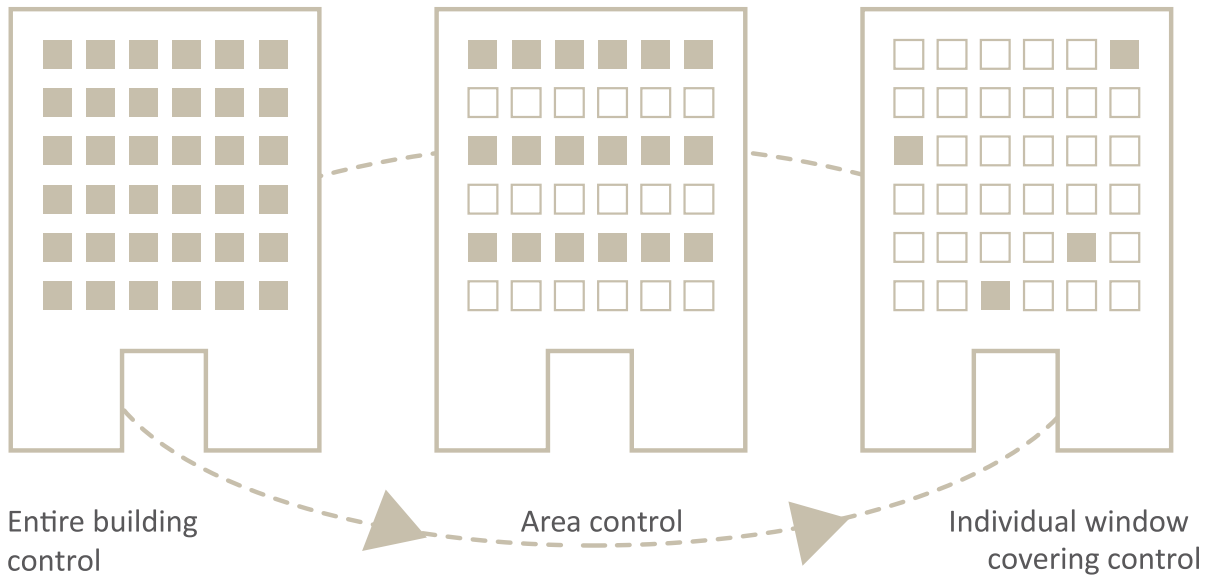

Specifications For Installation

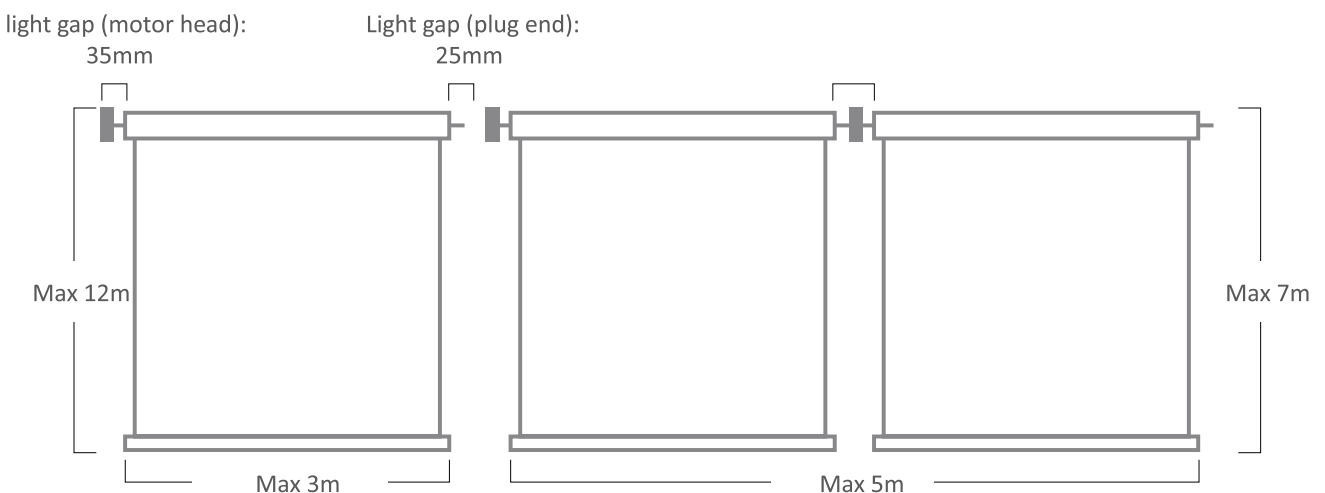

Soness 40 RTS - motorised roller blind system



Residential Villas



Hotel and commercial buildings

Applications

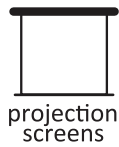
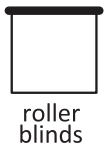

Main characteristics

- > Quiet operation below 50 dB(A)*
- > RTS embedded with Modulis and Solar protection functions compatibility
- > Integrated antenna
- > Remote limit settings
- > Black and thin round head for discreet blending
- > Standard round head compatible with LS40 standard accessories
- > Specific accessories specially designed for better acoustic quality
- > Same integration process as LS/Altus 40
- > Degree of protection: IP44, Operating temperature: 0°C to 60°C

*Acoustic pressure at 1 meter of the end-product at nominal torque

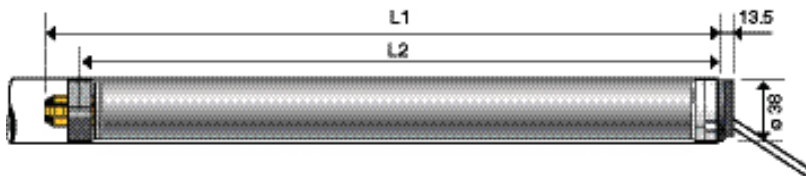

Certifications



Type of cable

230 V / 50 Hz
2 threads by wire

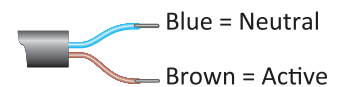
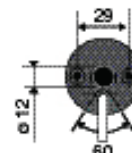

Performance

Nominal voltage	230 V / 50 Hz		
Torque	3 Nm	6 Nm	9 Nm
Speed	30 rpm	20 rpm	12 rpm
Radio frequency available for RTS	433,42 MHz		

Dimensions

L1 (in mm)	504	535	535
L2 (in mm)	480	511	511

Architectural Shading

Motorised Roller Blinds

Fortress Land Door Hardware

Personalize your blinds

High quality printing on your blind to personalize your room and your loved one's room. Decorating your room perfectly.

